

Accessories Specification

CLS-BE1210

—CLS series



Indoor

【Basic Parameters】

- Material: AL6063-T5,spraying surface/anodizing
- Coating: Iron Grey
- Length: 2500mm[98.43"]/0-2500mm[0"-98.43"] customizable(Other lengths on request)
- Application: Indoor
- Installation: Recessed
- IP grade: IP20
- Warranty: 5 years

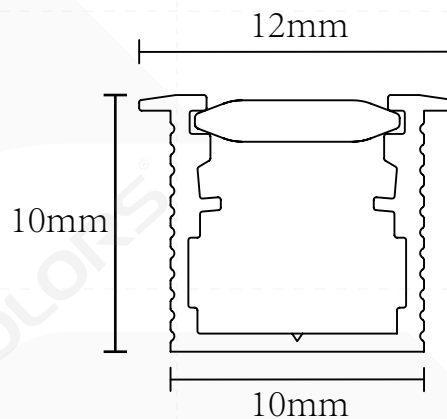

【Luminaire Parameters】

Version	Model	Length	Input Voltage (V)	Max. Current (A/m)	Type Power (W/m)	Max. Power (W/m)	CRI	CCT	Lumen (LM/m)
Normal	CLS-BE1210	1000mm (3.28ft)	24	0.4 (0.12A/ft)	9.6 (2.93W/ft)	10.6 (3.23W/ft)	>90	2300K	335 (101LM/ft)
								2700K	342 (104LM/ft)
								3000K	355 (108LM/ft)
								3500K	360 (110LM/ft)
								4000K	365 (111LM/ft)
								6000K	355 (107LM/ft)

Note:

- 1.The above parameters were tested based on 1M [3.28'] standard product and C6160-24V-7mm,Ra90,4000K light source;
- 2.luminous flux is allowed to have a ±15% error range;
- 3.The above parameters are typical values.
- 4.We assure you of consistent color spraying surface within the same batch.However, please be aware that we cannot guarantee color matching across different batches due to silver anodized process.

[Optical Parameter]

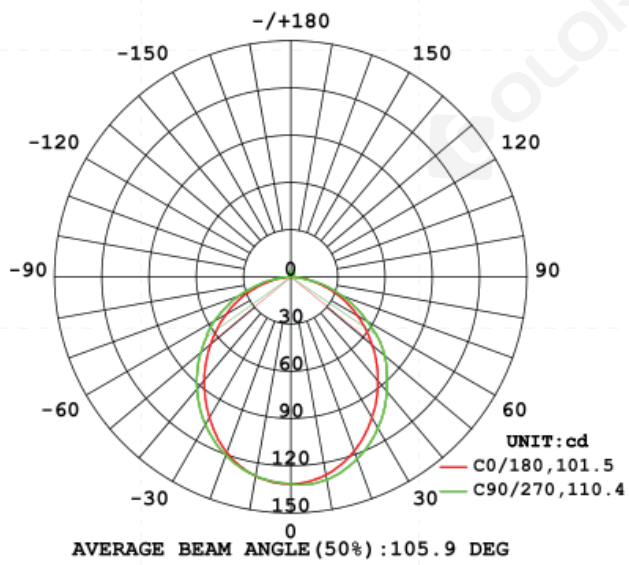

Luminous intensity distribution diagram

Flux out: 229.7 lm

Height	Eavg, Emax	Angle: 101.49deg	Diameter
1m	47.95, 131.61x		244.75cm
2m	11.99, 32.911x		489.50cm
3m	5.328, 14.631x		734.25cm
4m	2.997, 8.2271x		979.00cm
5m	1.918, 5.2651x		1223.75cm
6m	1.332, 3.6561x		1468.50cm
7m	0.9785, 2.6861x		1713.24cm
8m	0.7492, 2.0571x		1957.99cm
9m	0.5919, 1.6251x		2202.74cm
10m	0.4795, 1.3161x		2447.49cm





Note: The Curves indicate the illuminated area and the average illumination when the luminaire is at different distance.

AAI Figure

[Application]

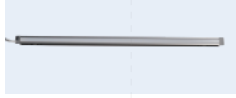
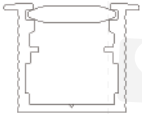

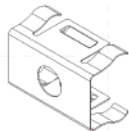
[Product Accessories Information]

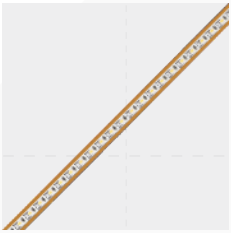
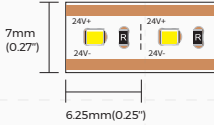
Picture	Section size	Name	Description	Model	Note
		Profile	Material: AL6063-T5 Surface processing: Anodizing Size: L2500*W12*H10mm [Inch size: L98.425"*W0.47"*H0.39"]	GLS-BE1210	/
		Clip	Size: 17*10*8.3mm [Inch size: L0.66"*W0.22"*H0.33"]	CLS-BE1210-CLP	/
	/	End caps	Wire: L1800mm*22AWG 1pcs cap with wire+1pcs cap no wire	CLS-BE1210-EC	/
		Flexible Strip	Material: SMD CCT: 2300/2700/3000/3500/4000/ 6000K CRI>90; Voltage: 24V; Power: 9.6W/M [2.9W/ft]; Lumen: 1265LM/M [385LM/ft]; Width: 7mm [0.27"]; Bend diameter: >60mm [2.36"]; Minimum cutting unit: 6.25mm [0.25"];	C6160-24V-7mm	/

[Packing]

Model	Modes of packing	Quantity /box	Quantity /carton	NW /carton/(kg)	Carton (kg)	GW /carton/(kg)	Size (mm/carton)
CLS-BE1210FDXIGX2500	Paper box	/	12	2.6	9.1	12.7	2680*125*115 [105.5"*4.9"*4.5"]

[Attentions]

1. Non-professionals are prohibited from installing, disassembling and repairing the product.
2. Avoid scratching, distortion and irregular bending of the product during installation; otherwise it may cause irreparable damage to the product.
3. Please use professional cutting tools when cutting
4. Do not use any acid or alkaline adhesive to fix products
5. The product is only suitable for indoor dry places, can not be used in outdoor, seaside or wet environment.
6. PC features: Each 10°C rise or drop will make diffuser extend or shrink 0.8mm/m[0.01"/ft], please confirm before processing and use